

Low Voltage Battery

USER MANUAL

LB-5S-G1
LB-10S-G1
LB-15S-G1
LB-20S-G1

About This Document

Purpose

This document describes the installation, commissioning, operation, troubleshooting, and decommissioning of the battery energy storage system (BESS). Please carefully read this manual before the installation, operation, and maintenance. This document is subject to update without notice. The latest version of this document and further information on the BESS are available in PDF format at <https://www.hoymiles.com>.

Scope of Validity

This document is valid for the following models:

- LB-5S-G1
- LB-10S-G1
- LB-15S-G1
- LB-20S-G1



Item	Meaning	Description
A	Series name	LB: Low voltage battery
B	Total energy	5: The total energy is 5.12 kWh.
C	Stackable	S: This battery is a stackable battery.
D	Generation	G1: The first generation.

Target Audience

This document is only for qualified personnel. Only qualified personnel who have been trained or mastered relevant skills can install and maintain the product under the guidance of this document.

The qualified personnel must possess the following skills:

- Knowledge of how batteries work.
- Knowledge of how an inverter works.
- Training in how to deal with the dangers and risks associated with the installation, maintenance, and use of electrical devices.
- Training in the installation and commissioning of electrical devices.
- Knowledge of all applicable laws, standards, and directives.
- Knowledge of and compliance with this document and all safety information.

Symbol Convention

Symbol	Description
	Indicates a hazard with a high level of risk that, if not avoided, will result in death or serious injury.
	Indicates a hazard with a medium level of risk that, if not avoided, can result in death or serious injury.

 CAUTION	Indicates a hazard with a low level of risk that, if not avoided, can result in minor or moderate injury.
NOTICE	Indicates a situation that, if not avoided, can result in property damage. NOTICE is used to address practices not related to personal injury.

Copyright

Copyright © Hoymiles Power Electronics Inc. All rights reserved.

No part of this document can be reproduced, transmitted, or transcribed in any form or by any means without the prior written permission of Hoymiles Power Electronics Inc.

CONTENTS

1	Safety Precaution	01
	1.1 Intended Use	01
	1.2 Safety Information	01
	1.3 Symbols on the Package and Label	02
2	Product Introduction	04
	2.1 Product Overview	04
	2.2 Button Instruction	05
	2.3 Indicator Definition	06
	2.4 System Diagram	06
3	Unpacking and Storage	07
	3.1 Unpacking	07
	3.2 Packing List	07
	3.3 Product Storage	08
4	Installation Instruction	09
	4.1 Environmental Requirements	09
	4.2 Space Requirements	10
	4.3 Stackable Quantity	10
	4.4 Installation Tools	10
	4.5 Installation Steps	11
5	Electrical Connection	14
	5.1 Ground Cable Connection	14
	5.2 Power Cable Connection	14
	5.3 Communication Cable Connection	15
6	Operation and Maintenance	15
	6.1 System Power-on	15
	6.2 System Power-off	16
	6.3 Routine Maintenance	16
	6.4 Troubleshooting	17
7	Handling Precautions and Guidelines for Product	18
8	Disposal	19
9	Technical Datasheet	20

1 Safety Precaution

The LB-(5-20)S-G1 series battery is designed and tested according to international safety requirements. However, certain safety precautions must be taken while installing, operating, and maintaining the battery. Please carefully read all safety instructions before installation, and observe all these safety instructions.

1.1 Intended Use

The LB-(5-20)S-G1 series is a BESS which is for residential applications.

- It is a low voltage Li-ion BESS.
- It can be installed indoors and outdoors.
- It must only be used as stationary equipment.
- Alterations to the product are not allowed unless authorized in writing by the supplier.
- Unauthorized alterations will void the guarantee and warranty claims. Hoymiles will not be liable for any damage caused by such unauthorized alterations.
- It is not suitable for supplying power to life-sustaining medical devices.
- Please ensure that there will be no personal injury due to the power outage of the battery system.
- It can only be used in countries where it is approved by battery suppliers.
- It should be used in accordance with the information provided in this document and local applicable standards and directives. Any other application may cause personal injury or property damage.
- The label must be permanently attached to the product.
- The safety instructions in this document are only supplements to local laws and regulations. Please follow local laws and regulations during installation, operation, and maintenance.

1.2 Safety Information

To prevent personal injury and property damage and to ensure the long-term operation of the product, read this section carefully and observe all safety information at all times. Failure to observe the prescribed instructions may potentially void the manufacturer's warranty. If in doubt, please contact Hoymiles.



Danger to life due to electric shock where surge protection is not used!

If there is no surge protection, a voltage surge can be conducted into the building and to other connected devices in the same system through power cables, network cables, or other types of cable. Touching live parts and cables may result in death or lethal injury due to electric shock.

- Ensure all devices in the same system and the inverter are integrated with an existing surge protection system or device.
- Install the surge protection device in accordance with local laws and regulations



Danger to life due to overvoltage!

Overvoltage can damage a measurement device and result in voltage being present in the enclosure of the measurement device. Touching the live enclosure of the measuring device results in death or lethal injuries due to electric shock.

- Only use measurement devices with a higher voltage range than the system battery voltage.
- Do not touch hot surfaces before it cools down.

Risk of injury due to the weight of the product!

If the product is lifted incorrectly or dropped while being transported or mounted, it may result in injury.

- Lift and transport the product carefully.
- Wear suitable personal protective equipment, and comply with local regulations during installation, operation, and maintenance.

! WARNING

Fire hazard!

- If the fire is not from the battery or not spread to the battery, please use FM-200 or a carbon dioxide fire extinguisher to put out the fire.
- If the battery pack catches fire, do not attempt to put out the fire and evacuate immediately. Keep damaged batteries isolated and call the local fire department. Immediately seek medical in case of breathing in toxic fumes.

Keep away from water!

- Keep the battery packs away from water. If any part of the battery system is submerged, there is a risk of electric shock and internal short-circuit.
- Do not reuse the battery if it has been submerged in water.







NOTICE







Damage to the battery system due to electrostatic discharge!

Internal components of the battery system can be irreparably damaged by electrostatic discharge.

- Ground yourself before touching any component.

1.3 Symbols on the Package and Label

Symbol	Usage
	Electric hazard This symbol indicates that there is a danger of electric shock. Failure to pay attention to the procedures, practices, or improper implementation may cause injuries or death.
	Warning This symbol indicates that there is a hazard that could damage the product.
	The product should be stored and installed away from explosive materials.
	Playing around the product is not allowed.
	The product must be stored and installed far from flammable materials.
	Please wear protective goggles when installing, operating, and maintaining the product.
	Observe the documentation. Read and understand all documentation supplied with the product.

	<p>WEEE Designation. Do not dispose of the product together with household waste. Dispose of the product in accordance with local disposal regulations for electronic waste.</p>
	<p>CE mark. The product complies with the requirements of the applicable EU directives.</p>
	<p>The battery is recyclable. The battery can be recycled by a professional recycling organization. Please refer to the relevant local regulations.</p>
	<p>This side up! This package must always be transported, handled, and stored in such a way that the arrows always point upwards.</p>
	<p>Fragile The package/product should be handled carefully and should never be tipped over or slung.</p>
	<p>Keep dry! The package/product must be protected from excessive humidity and must be stored under cover.</p>
	<p>No more than six (6) identical packages are to be stacked on each other.</p>

2 Product Introduction

2.1 Product Overview

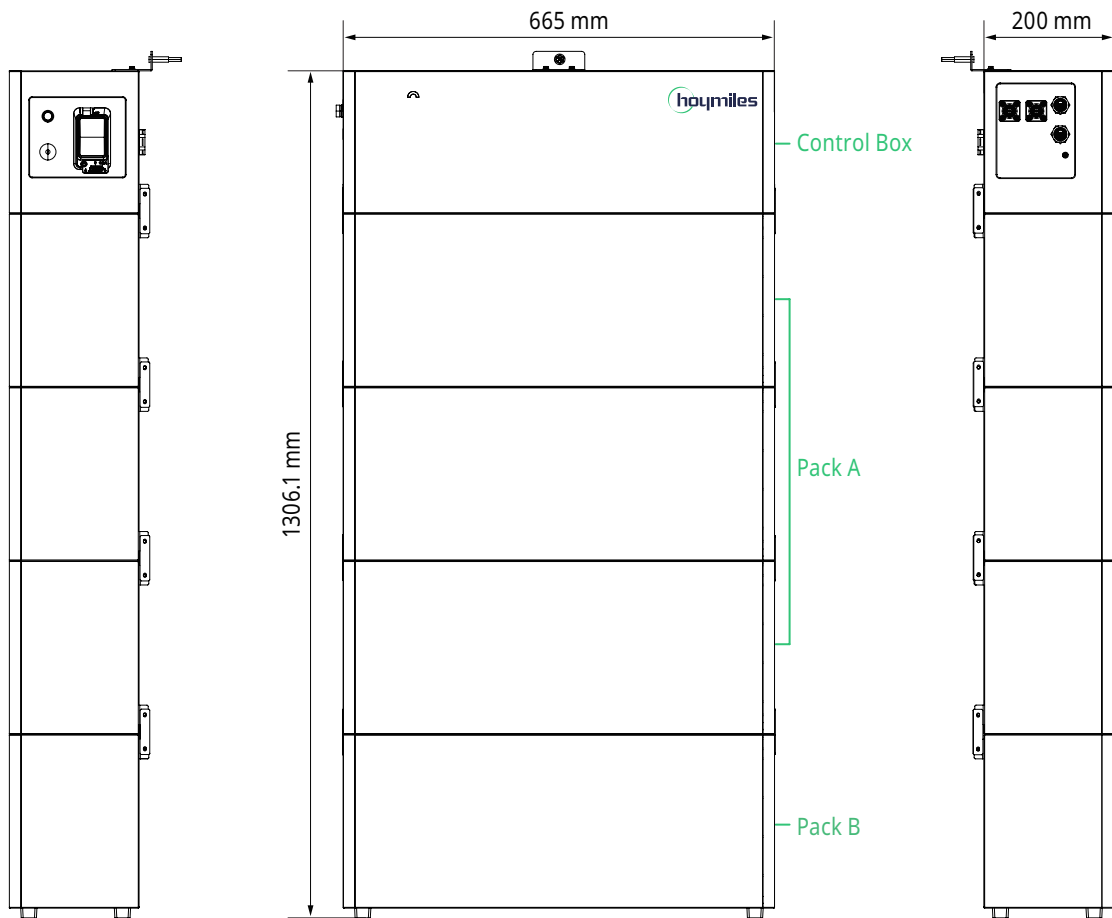

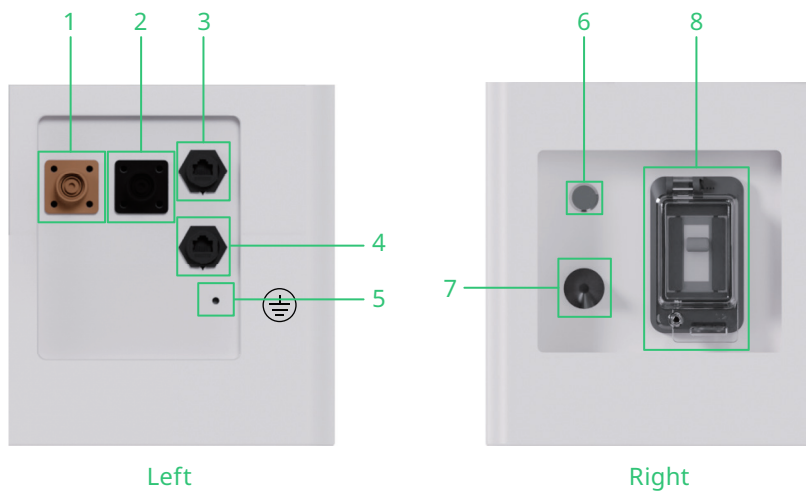

Note:

The quantity of Pack A can be 0, 1, 2, and 3.



No.	Description
1	Positive Terminal
2	Negative Terminal
3	PCS Communication Terminal (RS485/CAN) (COM1)
4	Reserved (COM2)
5	Ground Terminal
6	Reset
7	Wi-Fi
8	Circuit Breaker

Pin Definition	Terminal	1	2	3	4	5	6	7	8
	COM1	L-485-B	L-485-A	GND-L	CAN1H	CAN1L	GND-L	NC	NC
	COM2	E-485-B	E-485-A	GND-L	NC	NC	GND-L	E-485-A	E-485-B

2.2 Button Instruction



- **Activation**

When the BMS is in sleep mode, press the button for 3s to activate the BMS. At this moment, the BMS will enter the running mode, and the indicator flashes red, green, blue, yellow, purple, and cyan in turn every 300 ms.

- **Sleep**

When the BMS is in running mode, press the button for 6s to enter the sleep mode. At this moment, the indicator will be off after it flashes white 6 times (300 ms gap).









- **Reset**

When the BMS is in running mode, press the button for 10s, the indicator will be off and the BMS will be reset. Press the button for 3s to activate it again, and at this moment, the indicator flashes red, green, blue, yellow, purple, and cyan in turn every 300 ms.

- **Address Assignment**

When the BMS is in running mode, continuously press the button 2 times to enter the address assignment mode. At this moment, the indicator alternately flashes red and blue every 300 ms. The BMS will automatically enter the running mode after the address is successfully assigned.

2.3 Indicator Definition

Indicator	Indicator Status	Battery Status
	Flashing green every 1s.	The battery is charging.
	Solid green.	The battery is discharging.
	Solid blue.	The battery is in standby.
	Solid Red.	A fault occurs.
	The indicator is off.	1. The battery is turned off. 2. The battery is in sleep mode.
	Alternately flashing red and green every 300 ms.	The battery is upgraded.
	Alternately flashing red and blue every 300 ms.	Address assignment.
	Flashing red, green, blue, yellow, purple, and cyan in turn every 300 ms.	1. The battery is powered on and started. 2. Reset.

2.4 System Diagram

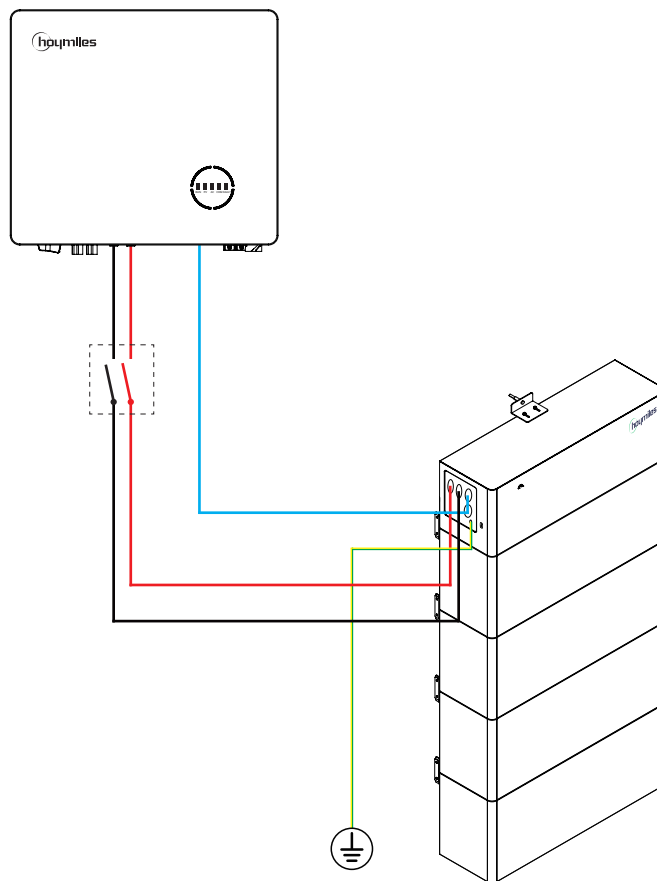

Note:

- The maximum output power is 7.68 kW. For the maximum output power of different models, please refer to "[9 Technical Datasheet](#)".
- A circuit breaker must be installed between the inverter and the battery. Install the circuit breaker in accordance with local laws and regulations.

3 Unpacking and Storage

3.1 Unpacking

Procedure	
<ul style="list-style-type: none"> Unpack the packages of control box, Pack A and Pack B. The diagram is an example of unpacking the control box package, and the steps of unpacking Pack A and Pack B are the same. 	

3.2 Packing List

Check that the deliverables are complete and intact after unpacking the battery. Please contact your supplier if the components are missing or damaged upon receipt of the battery.

Control Box Packing List			
Control Box*1	Bracket A*1	Bracket B*2	Power Cable*2
Communication Cable*1	Ground Cable*1	Screw M4*12*6	Screw M4*6*1
Expansion Screw M6*80*1	RJ45 Waterproof Terminal*1	Quick Installation Guide*1	Certificate*1

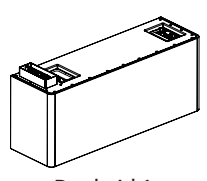
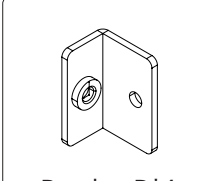
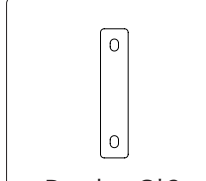
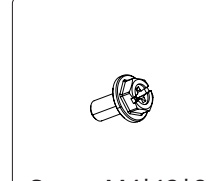
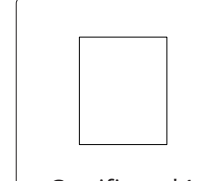
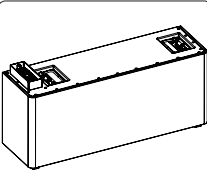
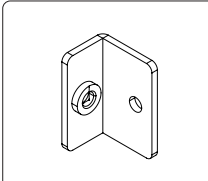
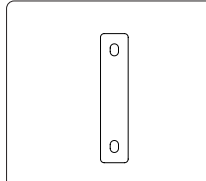
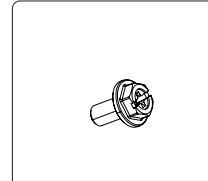
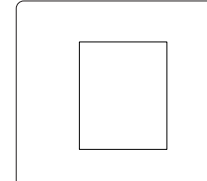
Pack A Packing List				
 Pack A*1	 Bracket B*4	 Bracket C*2	 Screw M4*12*8	 Certificate*1
Pack B Packing List				
 Pack B*1	 Bracket B*2	 Bracket C*2	 Screw M4*12*4	 Certificate*1

3.3 Product Storage

Suitable storage is required if the battery is not installed immediately:

- Store the battery in the original package, and do not unpack the battery.
- It is recommended to store the product in an environment with a temperature between 15°C and 35°C and a relative humidity between 10% and 95%, without condensing.
- The package with the battery shall not be tilted or inverted.
- Do not place any objects on the top of the battery pack.
- The battery should be stored in a cool and clean place where it can be protected from direct sunlight and bad weather such as rain, snow, or lightning.
- Keep the package away from flammable, explosive, and corrosive materials.
- If the battery has been stored for three months or longer, it must be fully inspected and tested by authorized personnel before it can be put into operation.
- The battery SOC should be 45%-50%. The battery needs to be recharged every 6 months if it is not used, and it is recommended to store it after it is first charged to 100%, then discharged to 50%, and finally powered off.
- The battery needs to be maintained at a maximum interval of 6 months.
- The requirements for the recharge interval after the battery is fully discharged are as follows.
 - a) If the environmental temperature is 45°C-50°C, it should be recharged within 7 days;
 - b) If the environmental temperature is 35°C-45°C, it should be recharged within 15 days;
 - c) If the environmental temperature is no more than 35°C, it should be recharged within 30 days.
- When the device is unused, the battery SOC should be 45%-55%, and the battery output should be disconnected to prevent the battery from draining.
- During the storage period of the system, professionals should regularly check the system to check whether the cables are loose, and clean the surface of the system; if any defects are found, please contact the dealer in time.

4 Installation Instruction



Danger to life due to fire or explosion!

- Despite careful construction, electrical devices can cause fires. This can result in death or serious injury.
- Do not mount the product in places containing highly flammable materials or gases.
- Do not mount the product in places where there is a risk of explosion.

4.1 Environmental Requirements

- The equipment should be installed on a solid surface such as concrete or masonry.
- The installation location must be inaccessible to children.
- The installation location must be suitable for the weight and dimensions of the battery.
- The equipment should be protected from conductive (metal) dust.
- The circuit breaker of the BESS must always be freely accessible.
- The recommended ambient temperature is between 15°C and 35°C.
- The operating temperature should be between -10°C and 50°C.
- The relative humidity should be between 10% and 95%.
- The altitude should be no more than 2000 m.
- If the product is installed outdoors, it should meet the following requirements, including but not limited to:
 - a) Avoid direct sunlight.
 - b) Avoid rain, snow, and flood.
 - c) Under the shelter if possible.
- If the product is installed indoors, it should meet the following requirements, including but not limited to:
 - a) Keep distance from doors, windows, driveway, or other batteries.
 - b) Keep away from the heating device.
 - c) Keep away from corrosive chemicals.
 - d) The product should be installed in an environment with good ventilation and heat dissipation conditions.

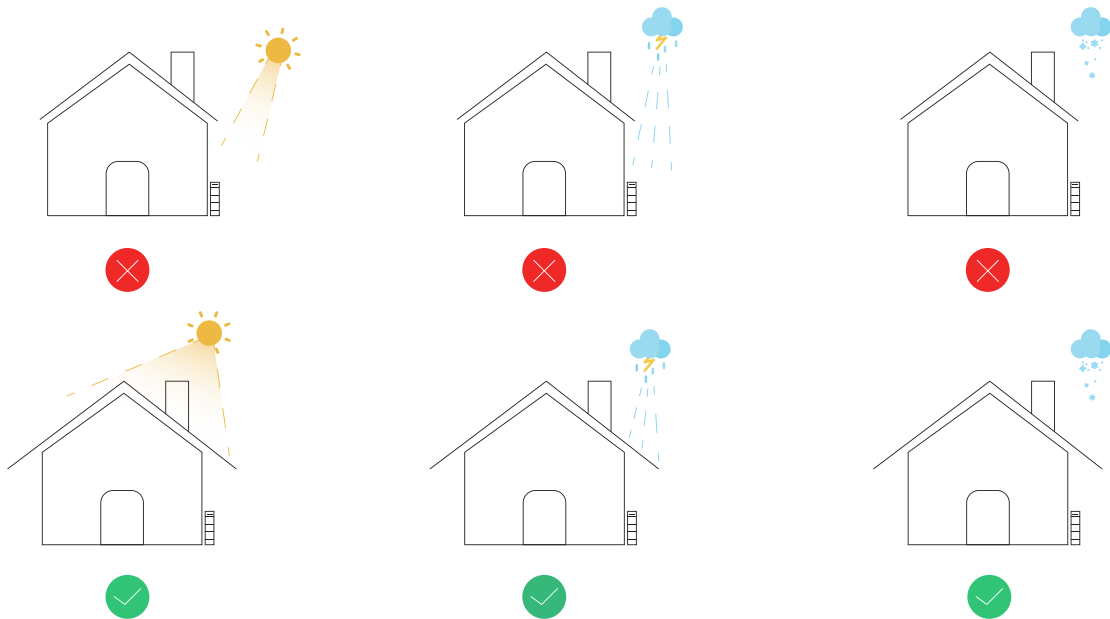

4.2 Space Requirements

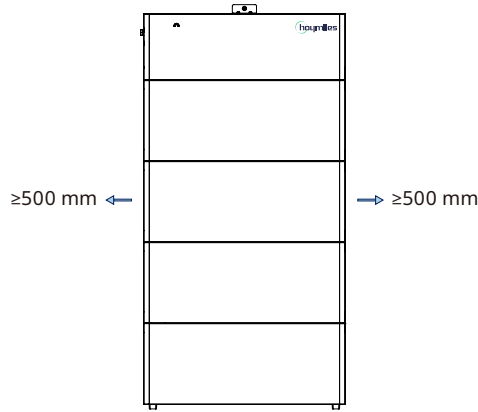

4.3 Stackable Quantity

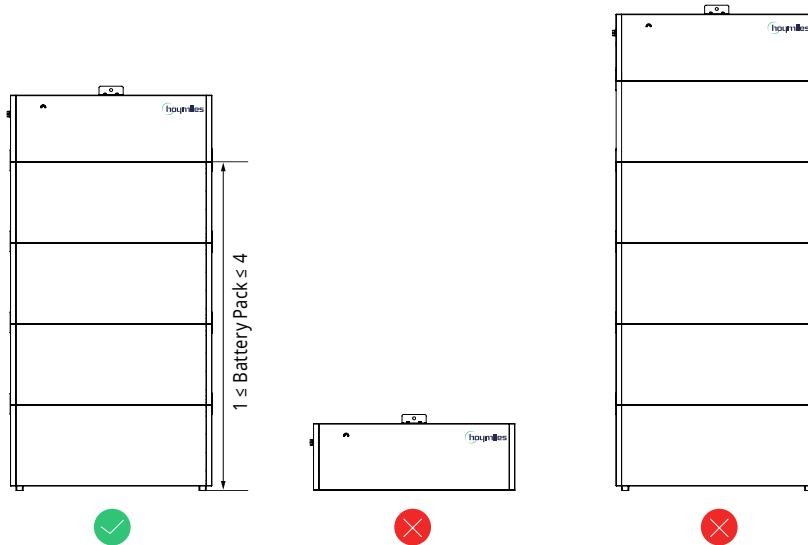

4.4 Installation Tools

The following tools are recommended in the installation process, and other auxiliary tools can also be used on-site if necessary.

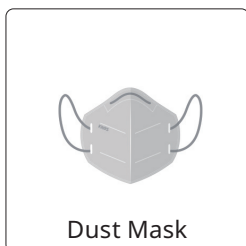
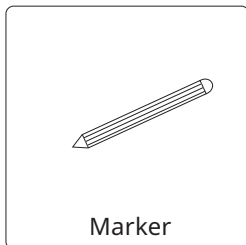
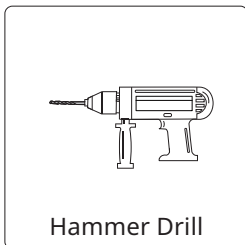
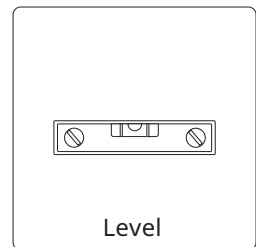
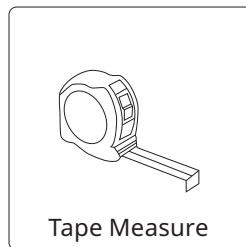
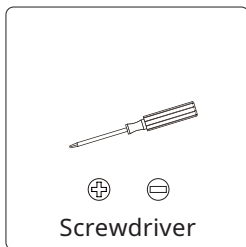

4.5 Installation Steps

Procedure	
Step 1	<ul style="list-style-type: none"> Fix the bracket A on the top of the control box with a torque of 5 N·m.
Step 2	<ul style="list-style-type: none"> Install the bracket B of control box, Pack A, and Pack B with a torque of 5 N·m.
Step 3	<ul style="list-style-type: none"> Use a detector to detect whether there are cables or water tubes behind the wall. Place Pack B on a level ground (0°-3°), parallel to the wall, and keep a distance of at least 20 mm. The handles are used to lift the pack off the ground and move it.

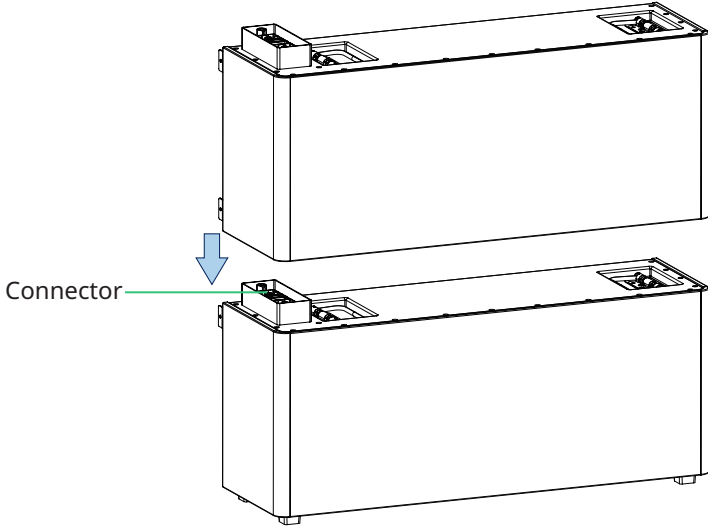
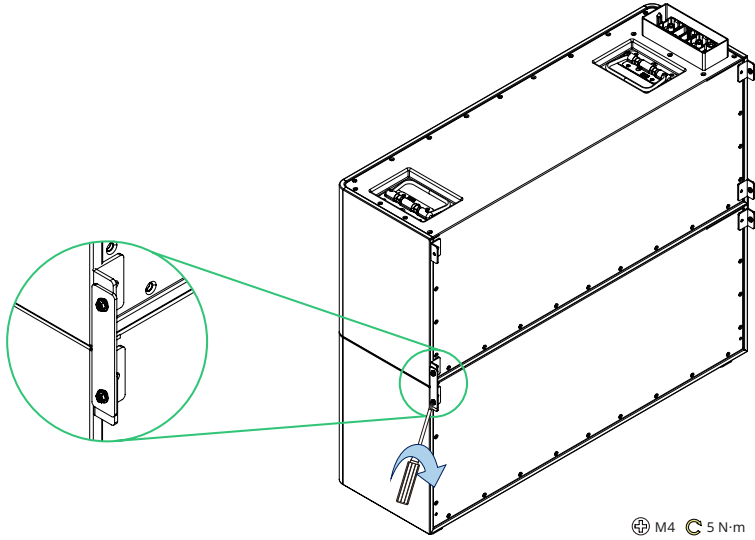
<p>Step 4</p>	<ul style="list-style-type: none">• Align the connector first.• Slowly put down the connector end of Pack A until the connector ends of the two packs are successfully connected.• Finally put down the other end of Pack A.
	
<p>Step 5</p>	<ul style="list-style-type: none">• Use bracket C to secure the connection between Pack A and Pack B. The remaining battery packs can be stacked layer by layer as shown in these figures.
	

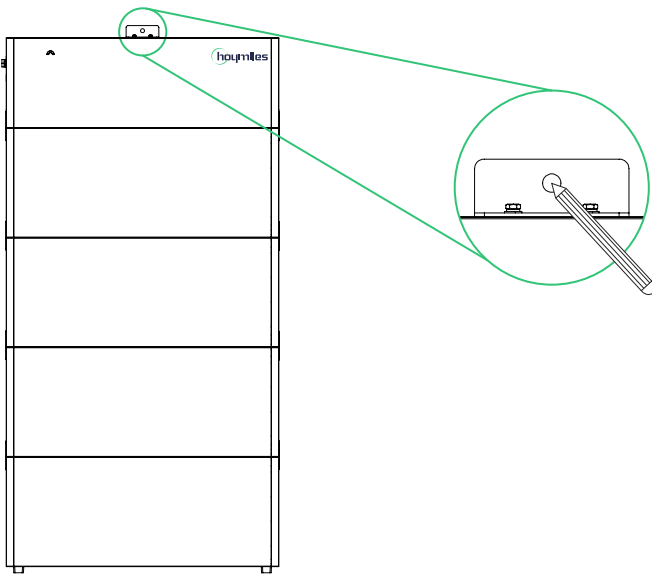
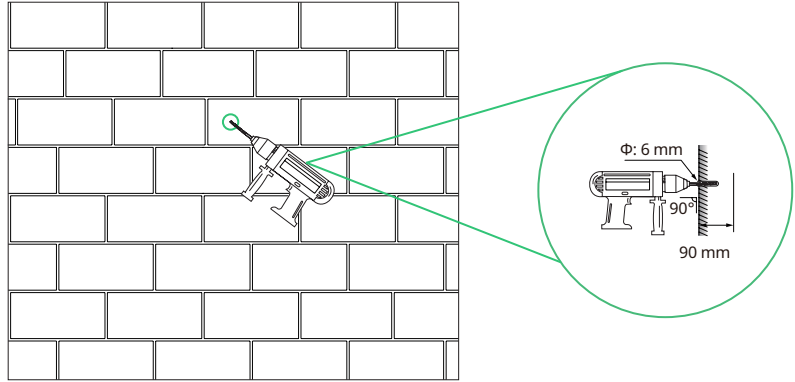
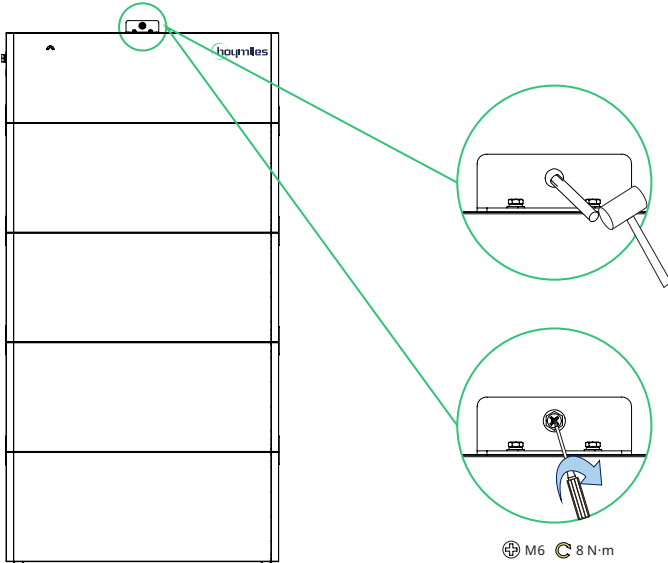
Step 6	Mark the hole position on the wall using a marker.
	
Step 7	<ul style="list-style-type: none"> Drill the hole on the wall with a diameter of 6 mm and a depth of 90 mm using a hammer drill.
	
Step 8	<ul style="list-style-type: none"> Place the anchor into the hole, insert the M6 screw into the anchor, and tighten it with a torque of 8 N·m.
 <p style="text-align: center;">⊕ M6 ⌚ 8 N·m</p>	

5 Electrical Connection

NOTICE

Before the electrical connection, ensure that the circuit breaker and power switch of the battery and all switches connected to the energy storage system are in the OFF state. Otherwise, an electric shock may occur.

Cable	Specification
Ground Cable	6 mm ² /10 AWG
Positive Cable	25 mm ² /4 AWG
Negative Cable	25 mm ² /4 AWG
Communication Cable	Standard communication network cable

5.1 Ground Cable Connection

Procedure

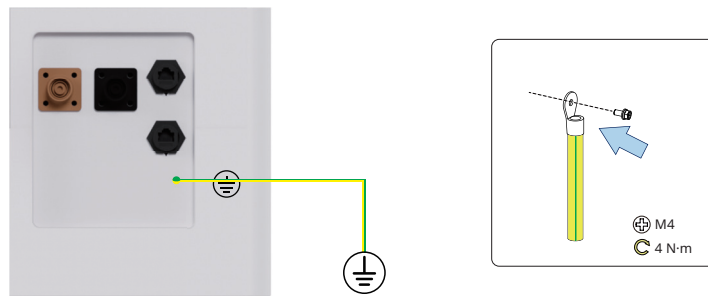

5.2 Power Cable Connection

Procedure



5.3 Communication Cable Connection

Procedure	
Step 1	Thread the communication cable through the RJ45 waterproof terminal.
Step 2	Insert the communication cable into the PCS communication terminal (COM1).
Step 3	Tighten the RJ45 cable cover.

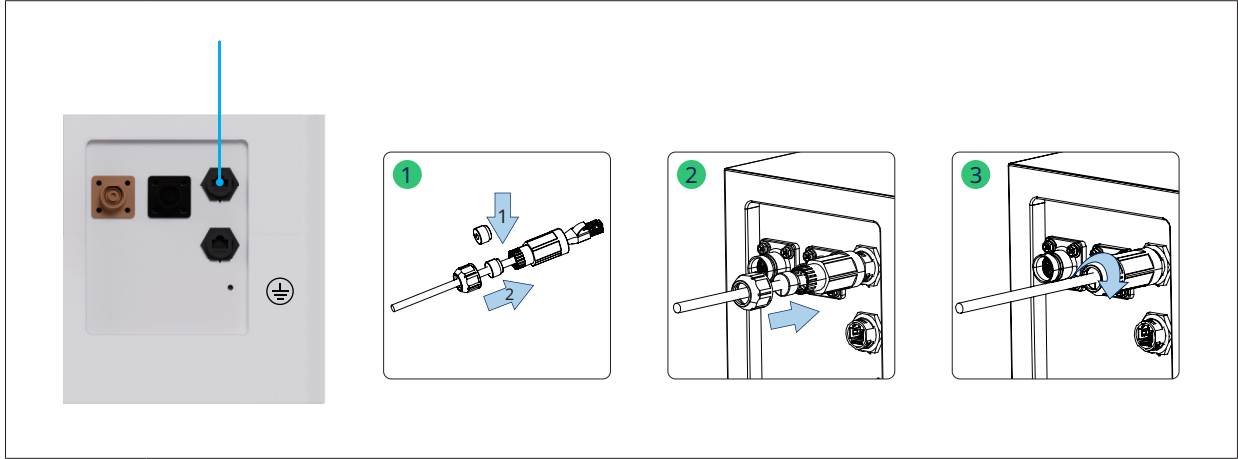

6 Operation and Maintenance

6.1 System Power-on

NOTICE

Ensure that all cables are connected correctly and firmly.

Procedure	
Step 1	Open the cover of the circuit breaker and turn on the circuit breaker.
Step 2	Press the "Reset" button for 3s. The indicator will flash red, green, blue, yellow, purple, and cyan in turn every 300 ms when the battery is powered on and started.

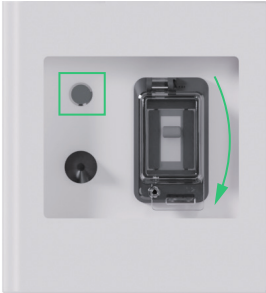

6.2 System Power-off

Procedure	
Step 1	Press the "Reset" button for 6s, and the indicator will be off.
Step 2	Open the cover of the circuit breaker and turn off the circuit breaker.
	

6.3 Routine Maintenance

To ensure that the battery can operate for a long time, it is recommended to perform the following maintenance items. Make sure that all maintenance items are performed after the battery is powered off.

Check Item	Check Method	Maintenance Interval
System Cleanliness	<ul style="list-style-type: none"> Periodically check whether the battery is damaged or deformed. Clean the system. 	Once every 6 months to 12 months
System Operation Status	<ul style="list-style-type: none"> Check whether there is abnormal sound during operation; Check whether the indicator works normally. Check whether the system parameters are set correctly. Update the software. 	Once every 6 months
Electrical Connection	<ul style="list-style-type: none"> Check whether the cables are firmly connected and intact; in particular, ensure that the parts being contacted with the metal surface are not scratched; Check whether the cable is discolored. 	The first inspection is 6 months after the initial commissioning, and the subsequent inspections can be carried out once every 6 to 12 months.
Grounding Reliability	<ul style="list-style-type: none"> Check whether the ground cables are firmly connected. 	The first inspection is 6 months after the initial commissioning, and the subsequent inspections can be carried out once every 6 to 12 months.

6.4 Troubleshooting

Fault	Possible Causes	Handling Suggestions
The "Reset" button has no response	The button is broken; The cables are damaged or not properly connected.	Please contact the supplier to repair or replace the control box.
The discharge time decreases	The battery capacity is insufficient.	Charge the battery until it is fully charged.
	Low ambient temperature.	Ensure that the product works within the recommended temperature range.
	Overload.	Check the load status and remove non-essential loads.
	Battery aging and capacity fading.	Please contact the supplier to replace the battery.
Unable to charge and discharge	Internal fault.	Log in to the S-Miles App, view the fault information, and contact the supplier.
	Overvoltage protection.	Log in to the S-Miles App, view the fault information, and contact the supplier.
	Undervoltage protection.	
	Overtemperature protection.	
	Undertemperature protection.	
	The battery is discharged to the protection SOC.	The battery should be charged to a value greater than the discharge protection SOC.
After the system is started, the indicator is not on or the indicator is abnormal	The indicator is broken.	Please contact the supplier to repair or replace the control box.
Battery communication is abnormal	The communication is disconnected.	Check whether the battery packs are installed reliably, and confirm whether the battery is abnormal through the battery indicator status.
The indicator is abnormal and flashes every 1s	Other faults.	Log in to the S-Miles App, view the fault information, and contact the supplier.
The battery doesn't work	The battery voltage is too low, or the battery SOC is lower than the shutdown protection value.	After the inverter is connected to the grid, charge the battery.

7 Handling Precautions and Guidelines for Product

These Handling Precautions and Guidelines for Rechargeable Battery System (“Handling Precautions and Guidelines”) shall only apply to the packs manufactured by Hoymiles. Customers shall strictly follow these Handling Precautions and Guidelines, and shall alert its customers, contract manufacturers, agents, distributors, service providers, and end-users of the risks of the packs. Customers should also ensure that they observe their obligations as specified in the document and the handling precautions and guidelines. Detailed information is available on the printed label of the product, a quick installation guide, a help file, or an official website. The entire chain including customers, distributors, and end-users should be committed to these obligations so that the product can be properly handled, transported, installed, operated, and maintained.

Statement (1):

Customers are requested to contact Hoymiles in advance, if and when customers need other applications or operating conditions other than those described in this document. Additional experimentation may be required to verify performance and safety under such conditions.

Statement (2):

Hoymiles will take no responsibility for any accidents in the event the product is used for applications or under conditions other than those described in this document.

- Use the product under specified charge/discharge conditions.
- Do not immerse the product in water.
- Do not heat the product.
- Do not attempt to crush, drop, or penetrate the product.
- Do not attempt to have any modifications.
- Leave the product in cool places.
- Stop using the product with any color change or mechanical damage detected during assembly, charging, normal operation, and storage.
- In case of leakage or smells, track to the thermal source, remove the thermal source, and clean it with water.
- Do not place or leave the pack and equipment in the reach of the children.
- Keep leaked electrolytes away from the eyes or skin. In case of leakage contact with eyes or skin, immediately clean with water and seek help from a doctor. Serious damages can be caused due to delayed treatment.
- Do not put the pack into a fire. Do not use it or leave it in a place near fire, heaters, or high-temperature sources. The heat can melt the pack insulator and damage the safety vent, resulting in overheating, explosion, or fire of the pack.
- Do not submerge the product in water or wet the product. If the protective devices are damaged, abnormal charging current and voltage may cause a chemical reaction within the product, which may result in overheating, explosion, or fire of the pack.
- Do not reversely connect the positive (+) and negative (-) terminals of the product.
- Do not contact the product terminals (+ and -) directly with a wire or any metal (like a metal necklace or a hairpin). Otherwise, the product will be short-circuited and generate excessive current, which may result in the overheating, explosion, or fire of the pack.
- Do not throw or drop the pack. Strong impact may damage the protective devices, and an abnormal chemical reaction might occur during charge, resulting in overheating, explosion, or fire of the pack.
- Do not drive a nail in, hit with a hammer, or stamp on the pack. Otherwise, the pack may be deformed and short-circuited, resulting in overheating, explosion, or fire of the pack.
- Do not solder the pack directly. Heat applied during soldering may damage the insulator of the safety vent and mechanism, resulting in overheating, explosion, or fire of the pack.
- Do not disassemble or alter the pack. The pack employs a safety mechanism and a protection device to avoid any danger. If they are damaged, the pack might overheat, explode, or catch fire.
- Do not put the pack in a microwave oven or a pressure cooker. Sudden heat may damage the sealing of the pack and may cause overheating, explosion, or fire of the pack.
- Do not leave the pack in a charger or equipment if it generates an odour and/or heat, changes color

and/or shape, leaks electrolytes, or encounters any other abnormality. In such a case, immediately take the pack out of the charger or equipment and keep it away from fire. Otherwise, the pack might overheat, explode, or catch fire.

- Stop charging or using the battery after the battery reaches its lifetime; otherwise, the battery might cause overheating, explosion, or fire.
- Do not use the pack beyond specified conditions. Otherwise, the pack might encounter overheating, damage, or performance deterioration.
- Read the instructions regarding the installation and operation to avoid damages due to incorrect operations.
- The battery may have insufficient power capacity after long storage.
- Knockoff or counterfeit battery.
- Any inconsistency among serial number, model number, and product code.

8 Disposal

Disposal of the system must comply with applicable local regulations for the disposal of electronic waste and used batteries.

- Do not dispose of the battery system with your household waste.
- Avoid exposing the battery to high temperatures or direct sunlight.
- Avoid exposing batteries to high humidity or corrosive environments.

For more information, please contact the original manufacturer.

9 Technical Datasheet

Model	LB-5S-G1	LB-10S-G1	LB-15S-G1	LB-20S-G1
System Data				
Battery type	LiFePO ₄			
Rated capacity (Ah)	100	200	300	400
Number of modules	1	2	3	4
Total energy (kWh)	5.12	10.24	15.36	20.48
Rated voltage (V)	51.2			
Voltage range (V)	44.8-57.6			
Rated charging/discharging current	0.5C			
Max. continuous charging/discharging current (A)	50	100	150	150
Max. charge/discharge power (kW)	2.56	5.12	7.68	7.68
Communication	CAN, RS485			
Recommended depth of discharge (DOD)	90%			
Protection				
Overvoltage and undervoltage protection	Integrated			
Overcurrent protection	Integrated			
Overtemperature and undertemperature protection	Integrated			
DC breaker	Integrated			
General				
Dimensions (W × H × D [mm]) ⁽¹⁾	665 × 503 × 200	665 × 770.7 × 200	665 × 1038.4 × 200	665 × 1306.1 × 200
Weight (kg) ⁽¹⁾	61.5	109.5	157.5	205.5
Installation environment	Indoor/Outdoor			
Charging temperature (°C)	0 to +50			
Discharging temperature (°C)	-10 to +50			
Protection degree	IP65			
Cooling	Natural convection			
Altitude (m)	≤2000			
Cycle life (25°C, 0.5C)	6000 Cycles, @90% DOD, 70% EOL			
Certification	IEC 62619, UN 38.3			
Warranty ⁽¹⁾	5-10 Years			

*Parallel connection between battery towers is not supported.

(1) Please refer to Hoymiles Warranty Terms & Conditions for more details.



Floor 6-10, Building 5, 99 Housheng Road, Gongshu District,
Hangzhou 310015
P. R. China
+86 571 2805 6101

General inquiry: info@hoymiles.com
Technical support: service@hoymiles.com

Visit <https://www.hoymiles.com/> for more information.